

*Kalitemiz Sözümdür*

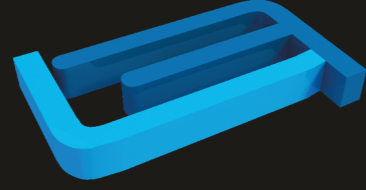

BİRLİK TİCARET MERMER KESİCİLERİ VE AŞINDIRICILARI İMALATI



# BİRLİKTİCARET

## BİRLİK TİCARET MERMER KESİCİLERİ VE AŞINDIRICILARI İMALATI

Firmamız 2010 yılında kurulup, mermer kesicileri ve aşındırıcıları imalatı yapmaktadır. Elektrolize elmas kesimi ile madeni ve doğal taşlarda daha hızlı bir şekilde talaş kaldırma işçiliği kolaylaştırma, daha hassas ölçüler elde etmek ve aynı ölçüleri koruyacak işçilik uğraşını en asgari seviyeye indirecek ve daha güzel yüzeyler elde edecek ekipmanlar üretmektedir.

Mermer sektöründe, elektrolizli kesim teknolojisi ile cnc aparatları, testereler, matkaplar, standart ve isteğe göre özel profiller ile firmamız sizlere kolaylık sağlamaktadır. Uygun fiyatlarla, sizleri seri imalata ve daha hızlı üretime yol açmakla beraber, memnun etmek ve yardımcı olmak için firmamız hizmet vermektedir.



Profiller - Testereler - Matkap Uçları - Karot Delicileri - Spiral Kesiciler  
Mozaik Kesim Kalıpları - Mozaik Dizgi Kalıpları  
Özel projelerinize göre de üretim yapmaktadır.

# Özel Profiller

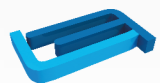
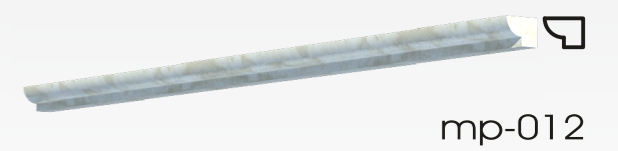
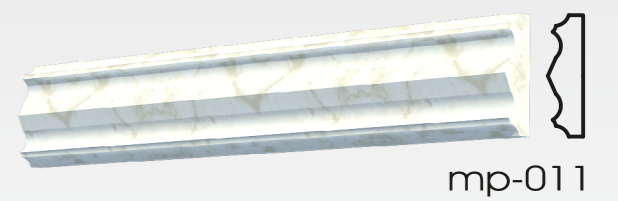
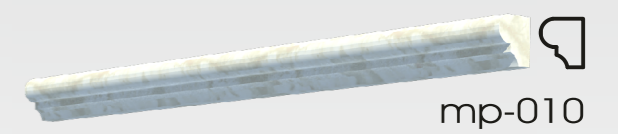
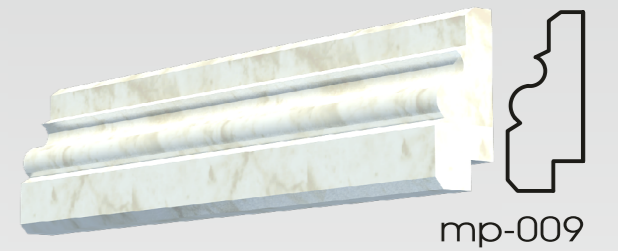
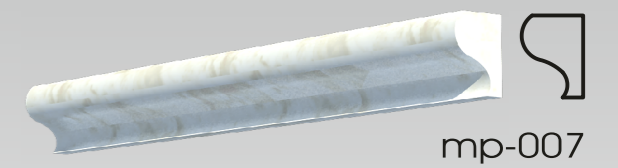
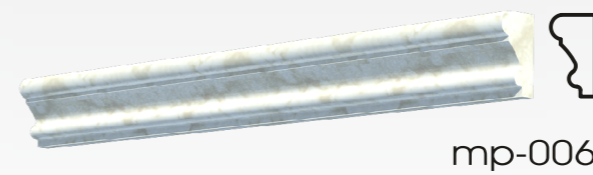
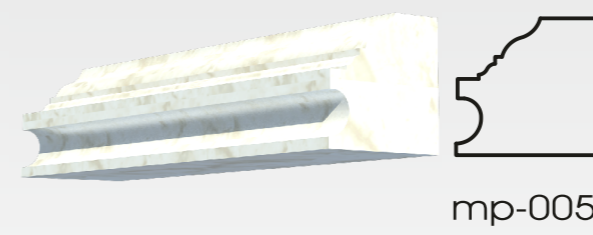
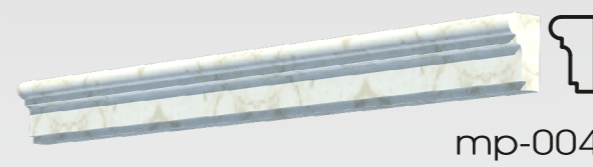
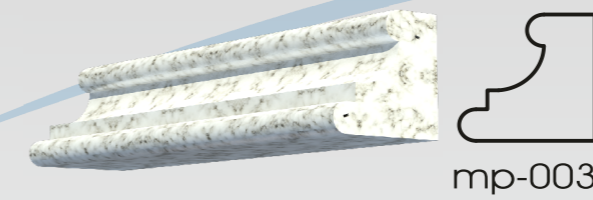
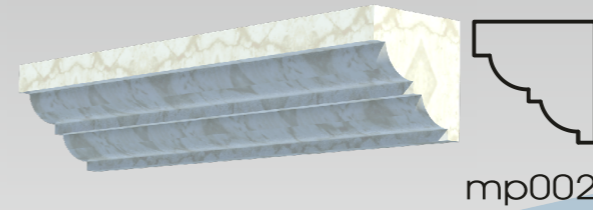
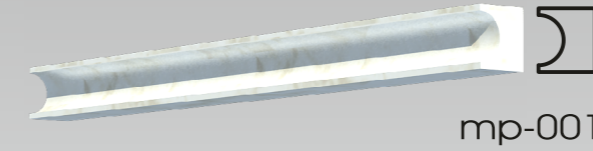
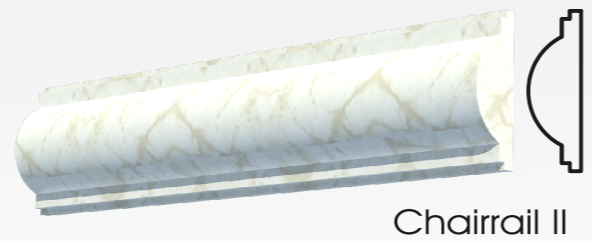
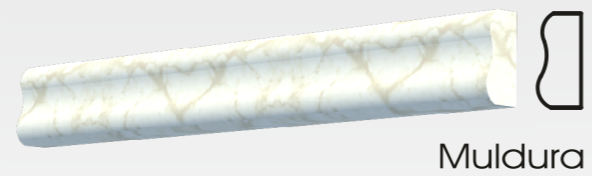
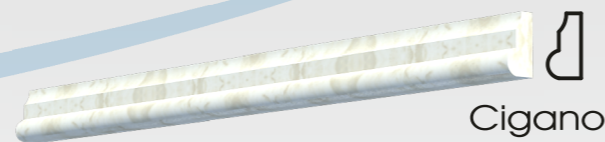
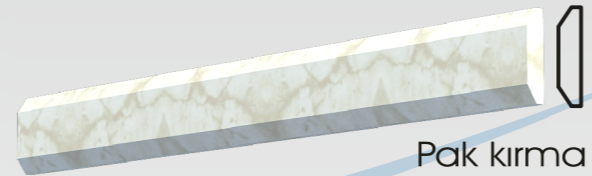
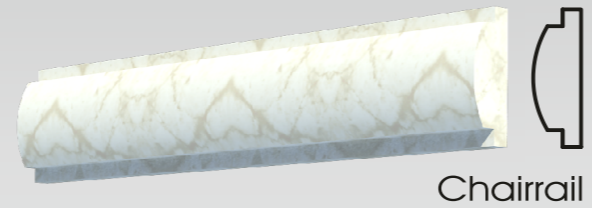
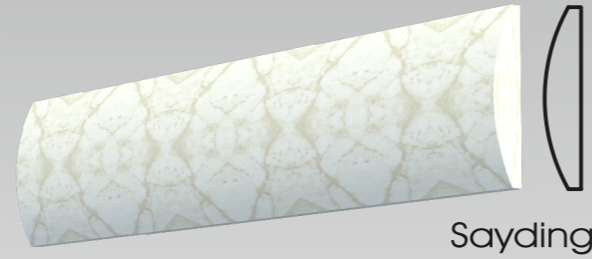
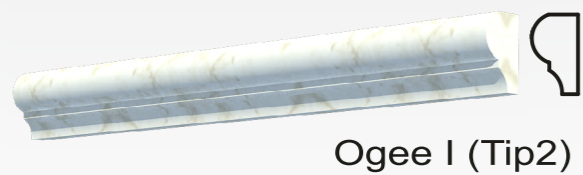
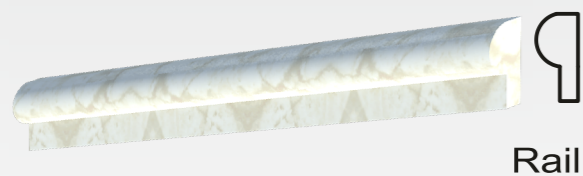
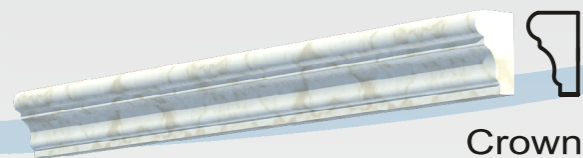
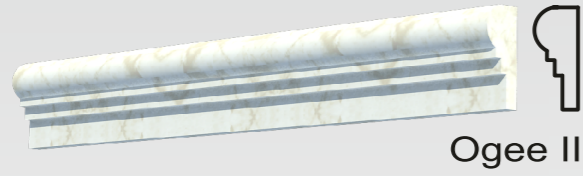
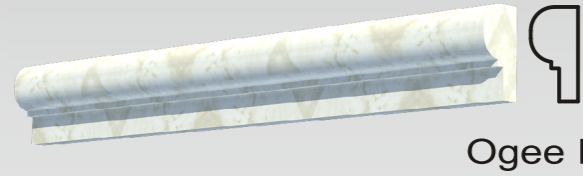

## Moulding & Profil

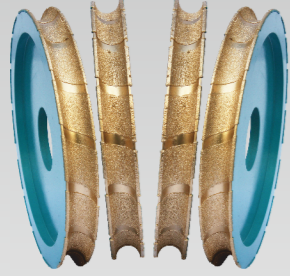

bullnose



ogee I

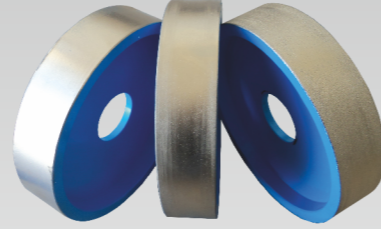

tarama



mp-015



mp-016

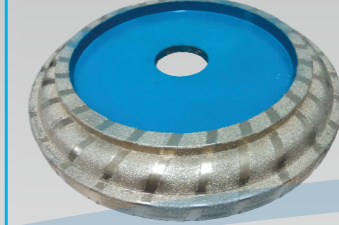

mp-017



mp-018

Birlik Ticaret elektrolyze profilleri ile hızlı kesim, yüksek metraj ve hassas ölçüler elde edilebilir profiller üretilmektedir.

Bu profiller madeni taş ve doğal taş mimari uygulamalarında kapı, pencere söveleri, havuz kenarları, merdiven kornişleri, saçak, şömine, süpürgelik ve sütunlarda ihtiyaç duyulan profiller ile estetik ve değer katmaktadır.

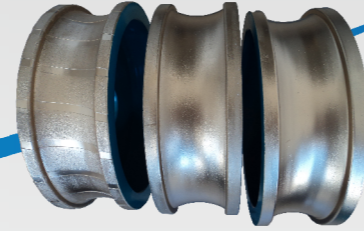

chairrail



mp-019

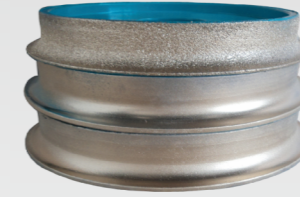

mp-020



mp-021

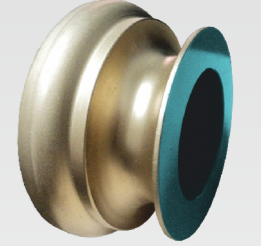

mp-022

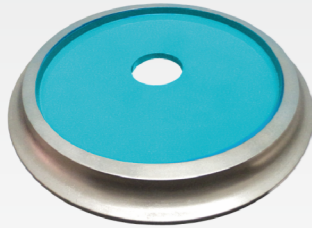

balık sırtı



mp-013

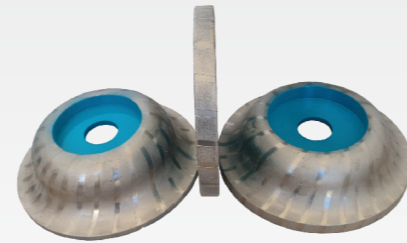

mp-014

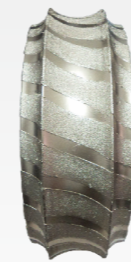

mp-023



mp-024



mp-025



mp-026

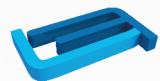

# CNC Delici Matkaplar



cd-001



cd-002



cd-003

Birlik Ticaret bünyesinde üretilen elektrolize matkaplar ile cnc router ve çeşitli el aletlerinde kullanılarak her türlü şekil verme oyma ve delme işleri yüksek hızda yapılmaktadır.

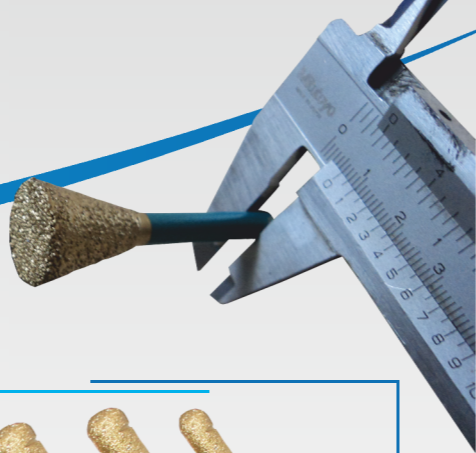

cd-004



cd-005



cd-006

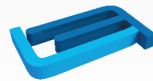
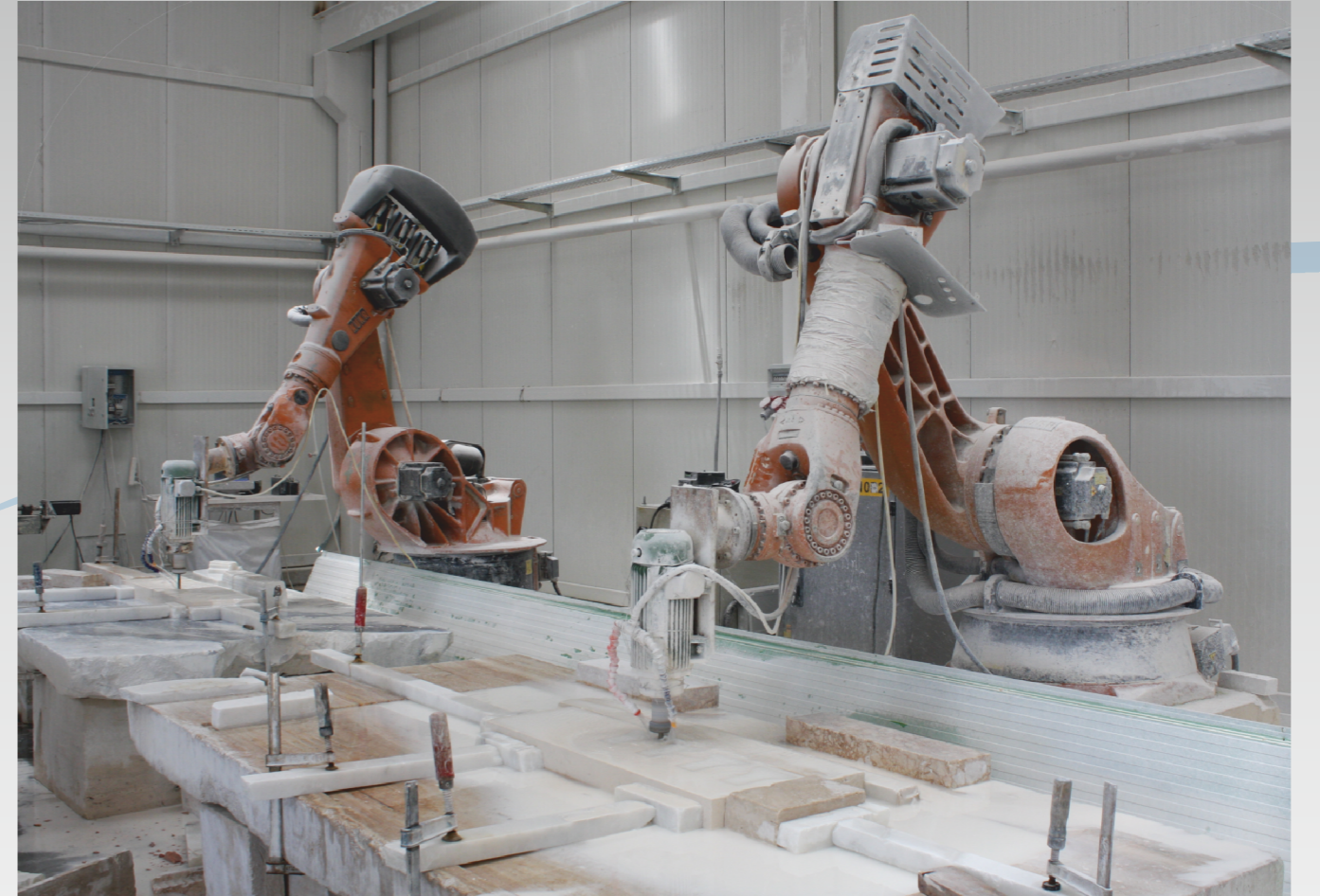

## Spiral Kesicileri

## Testereleler

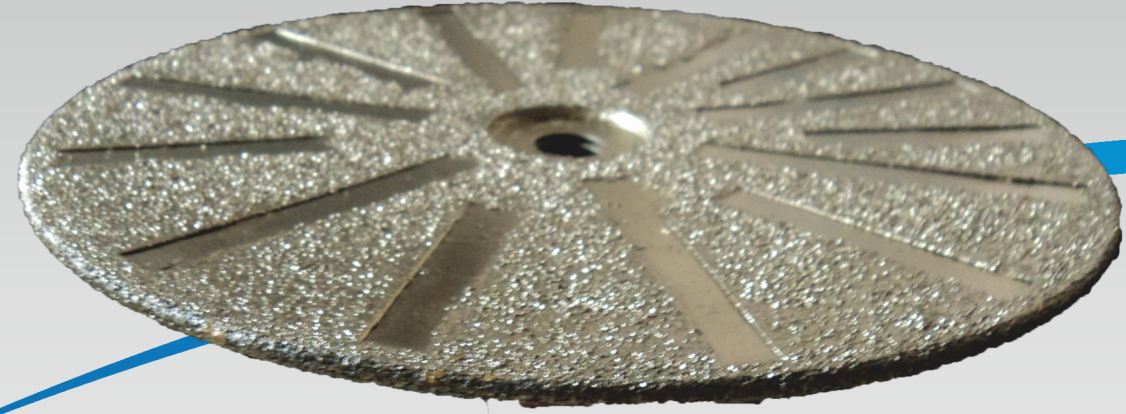
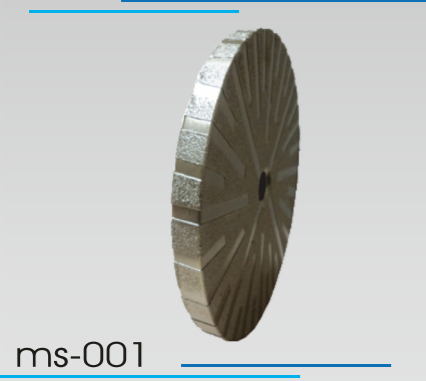

Birlik Ticaret bünyesinde üretilen elektrolize spiral kesicileri ile el işçiliğini minimum'a düşürmeyi, aynı ölçüleri korumayı, iş hızını yükseltmeyi ve istediğiniz mimari projeleri uygulamanıza büyük bir olanak sağlar



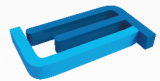
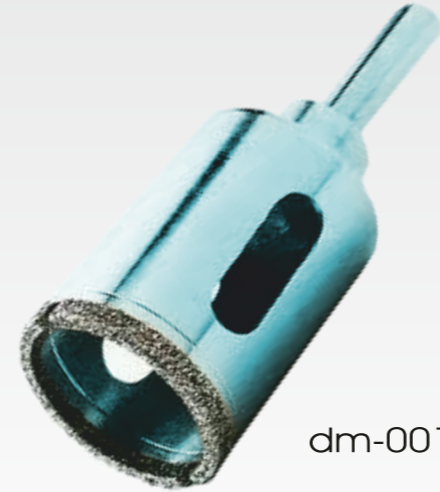
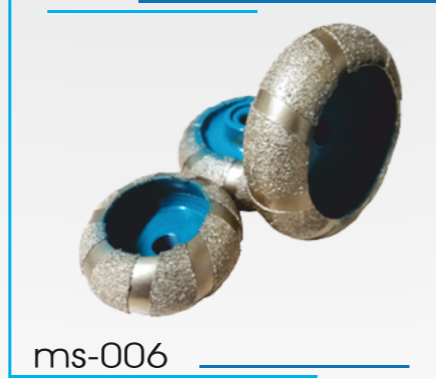

## Evye & Karotlar

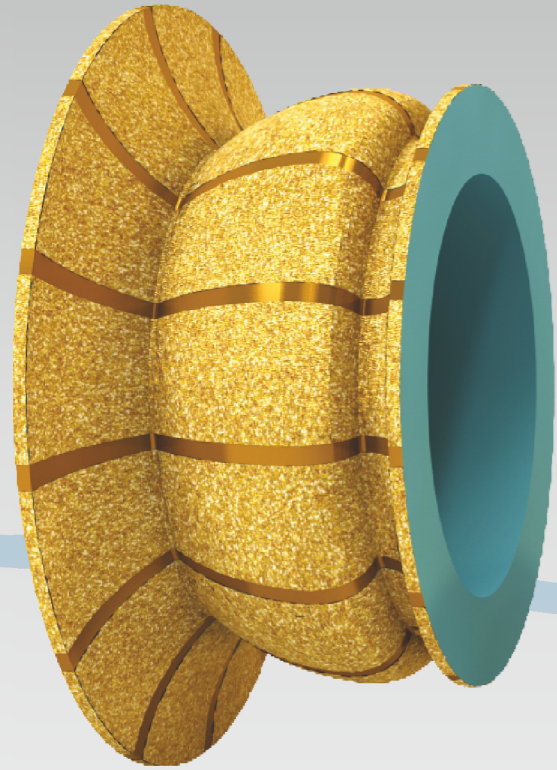



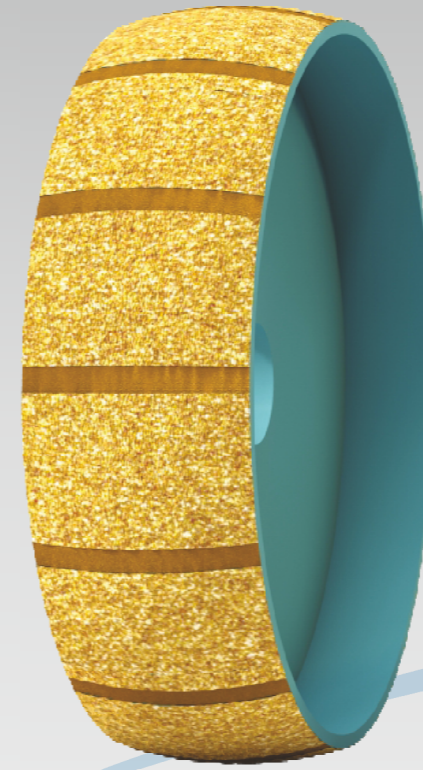
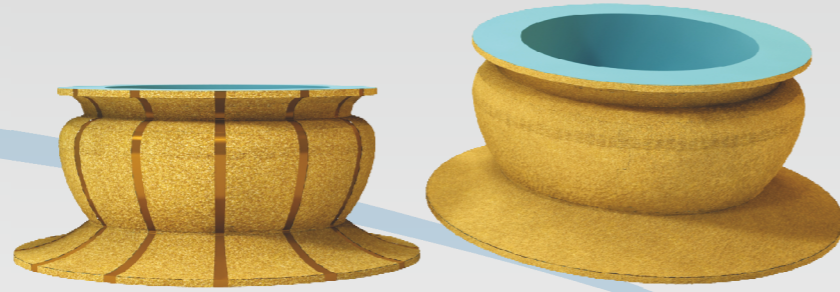

## Kanca

Teknik Özellikler		Size
 Profil Ölçüsü	(Profile Measure)	Ø250 mm x 115 mm
 Taş Ölçüsü	(Stone Measure)	107 mm x 72 mm
 Ambalaj Ölçüsü	(Packing Measure)	300 mm x 310 mm



## Delray

Teknik Özellikler		Size
 Profil Ölçüsü	(Profile Measure)	Ø250 mm x 80 mm
 Taş Ölçüsü	(Stone Measure)	80 mm x 51 mm
 Ambalaj Ölçüsü	(Packing Measure)	266 mm x 266 mm

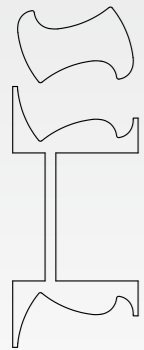
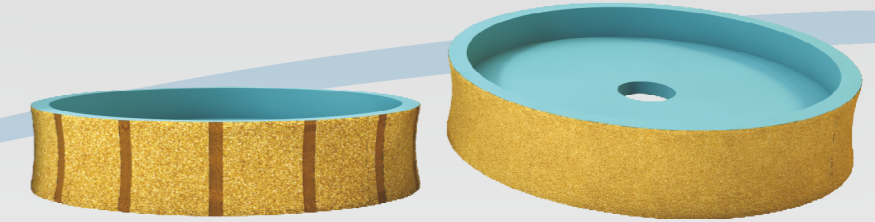

Profil  
Çizimi

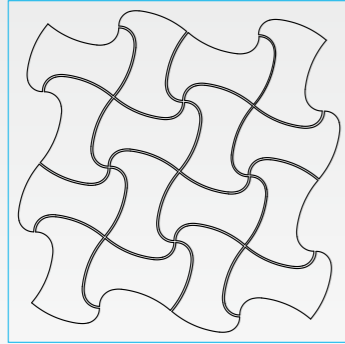

File  
Çizimi



Dizgi Kalıbı  
Kauçuk

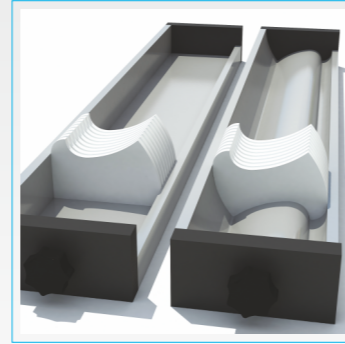

Kesim Kalıbı  
Alüminyum

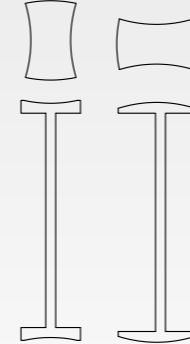

Profil  
Çizimi

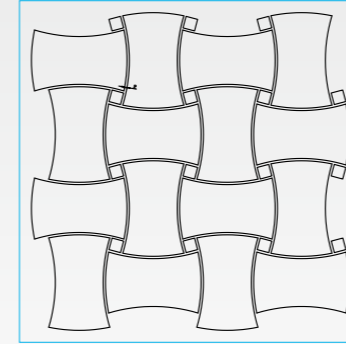

File  
Çizimi

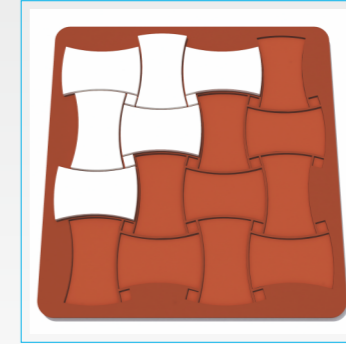

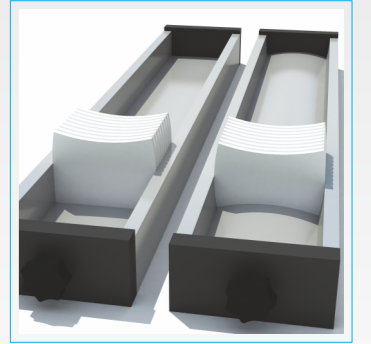

Dizgi Kalıbı  
Kauçuk



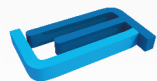

Kesim Kalıbı  
Alüminyum



## Papatya

Teknik Özellikler		Size	
 Profil Ölçüsü	(Profile Measure)	Ø250 mm	x 75 mm
 Taş Ölçüsü	(Stone Measure)	63 mm	x 63 mm
 Ambalaj Ölçüsü	(Packing Measure)	323 mm	x 326 mm

## Papatya 2

Teknik Özellikler		Size	
 Profil Ölçüsü	(Profile Measure)	Ø250 mm	x 65 mm
 Taş Ölçüsü	(Stone Measure)	63 mm	x 63 mm
 Ambalaj Ölçüsü	(Packing Measure)	285 mm	x 285 mm

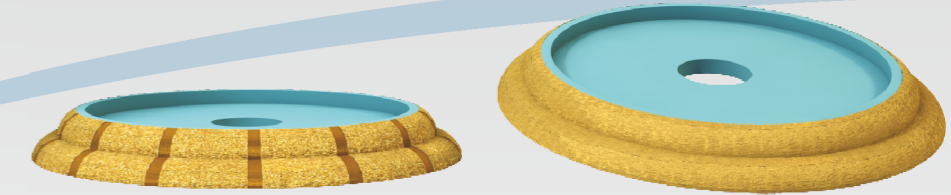
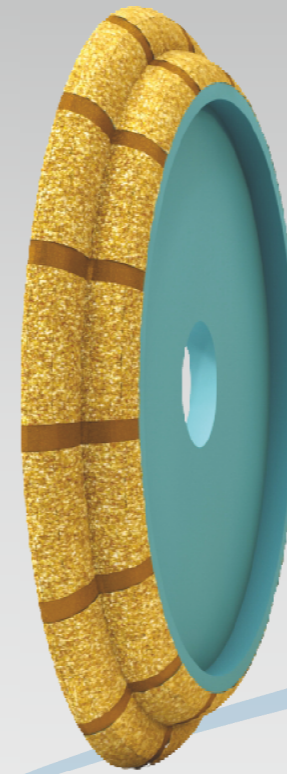
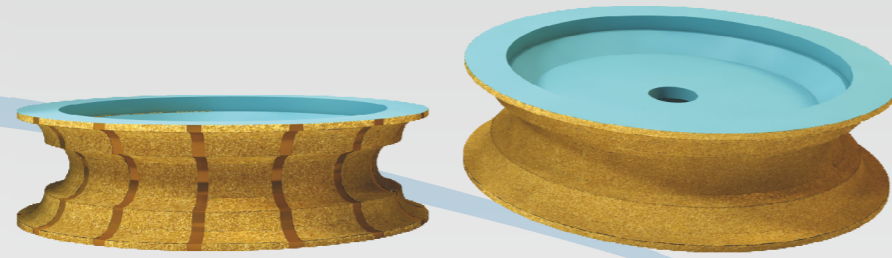
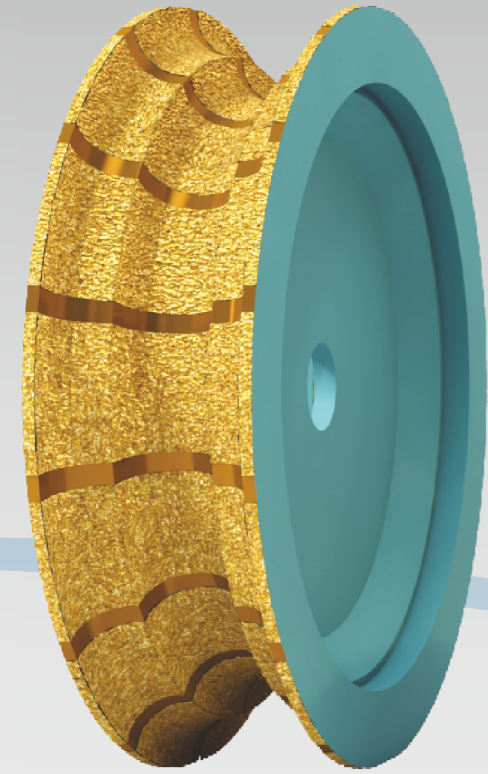

Profil Çizimi

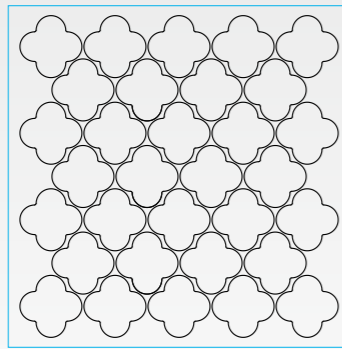

File Çizimi

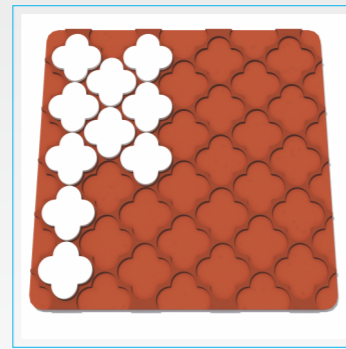
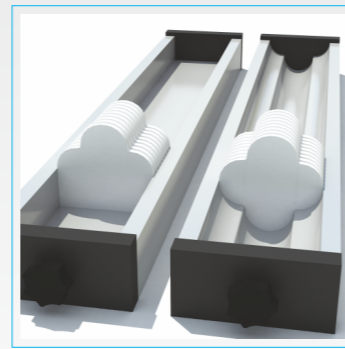
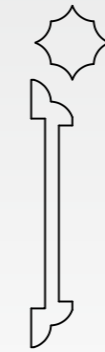
Dizgi Kalıbı  
KauçukKesim Kalıbı  
Alüminyum

Profil Çizimi

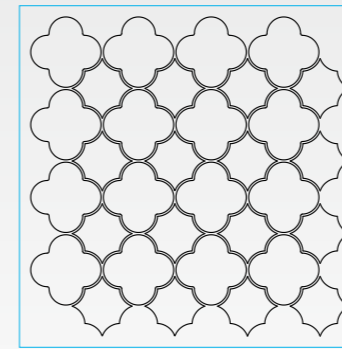

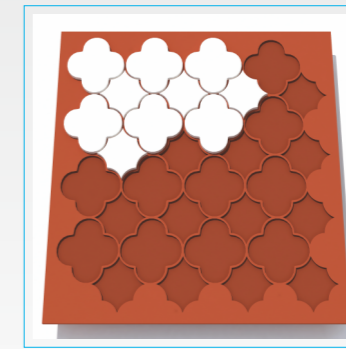
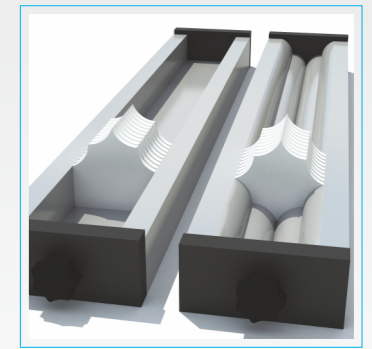
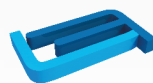

File Çizimi

Dizgi Kalıbı  
KauçukKesim Kalıbı  
Alüminyum



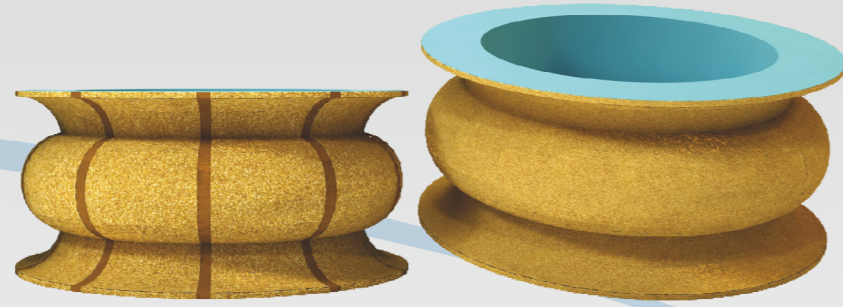

## Kemik

Teknik Özellikler		Size
 Profil Ölçüsü	(Profile Measure)	Ø250 mm x 140 mm
 Taş Ölçüsü	(Stone Measure)	128 mm x 67 mm
 Ambalaj Ölçüsü	(Packing Measure)	330 mm x 330 mm



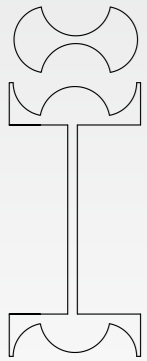
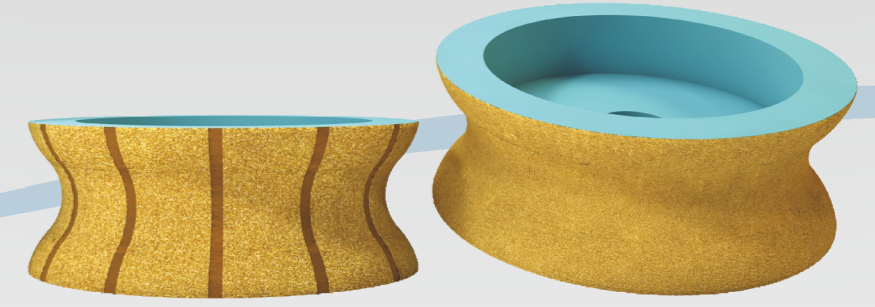
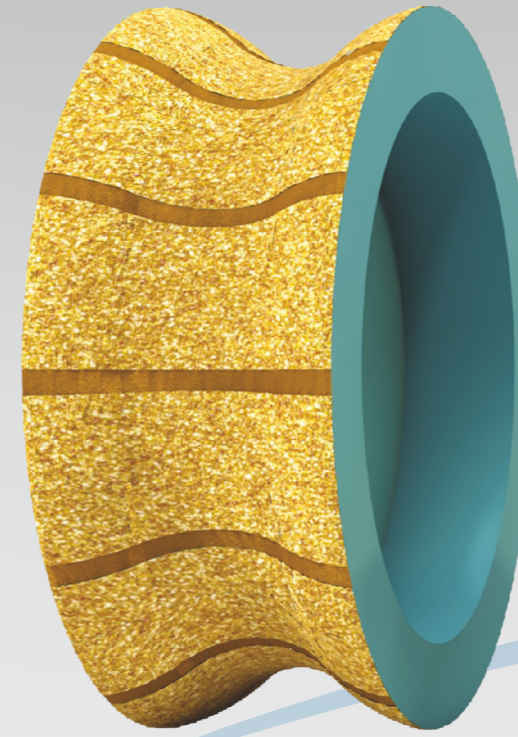
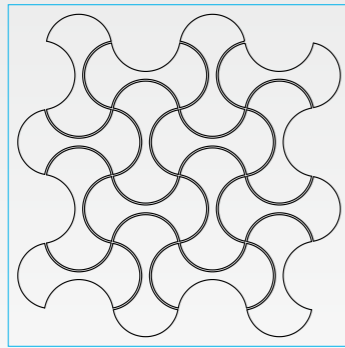
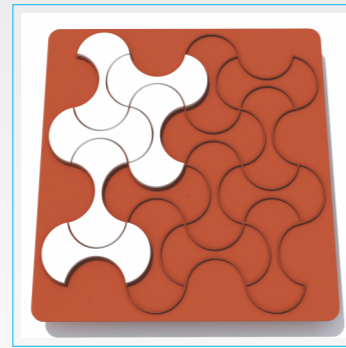
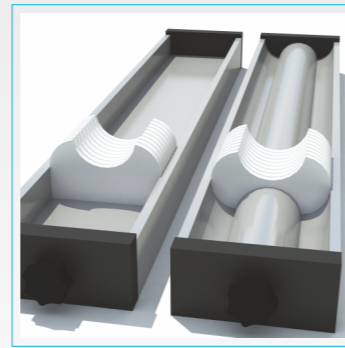
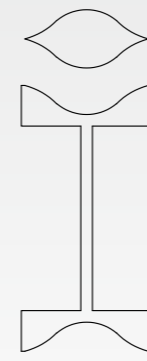
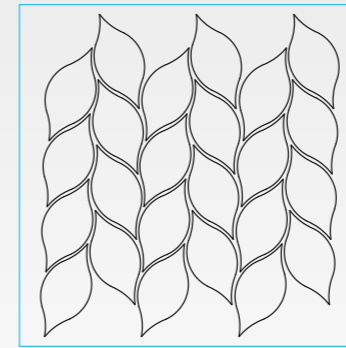
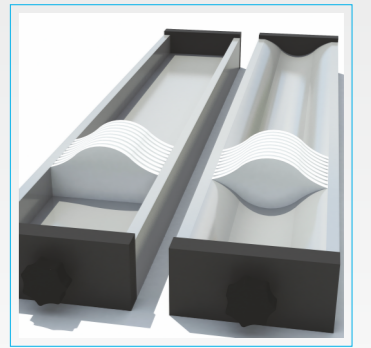
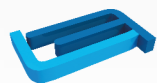

## İnce Limon

Teknik Özellikler		Size
 Profil Ölçüsü	(Profile Measure)	Ø250 mm x 110 mm
 Taş Ölçüsü	(Stone Measure)	100 mm x 50 mm
 Ambalaj Ölçüsü	(Packing Measure)	300 mm x 300 mm



Profil  
ÇizimiFile  
ÇizimiDizgi Kalıbı  
KauçukKesim Kalıbı  
AlüminyumProfil  
ÇizimiFile  
ÇizimiDizgi Kalıbı  
KauçukKesim Kalıbı  
Alüminyum

## İnce Yaprak

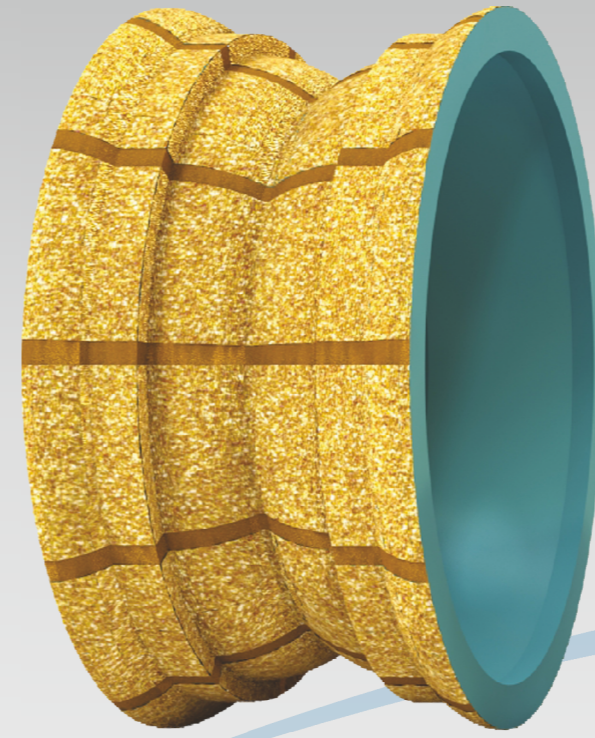
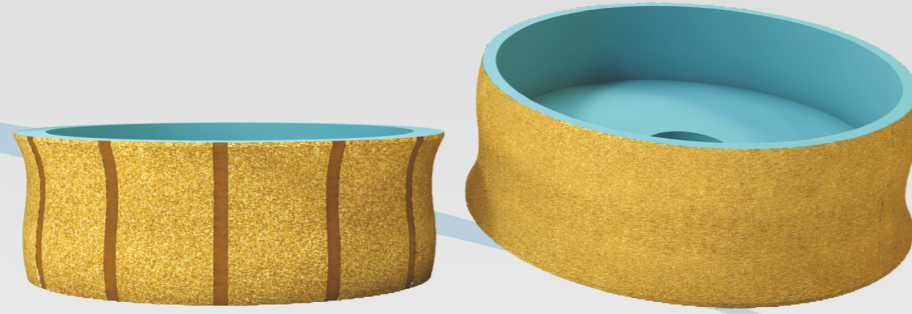
Teknik Özellikler		Size
 Profil Ölçüsü	(Profile Measure)	Ø250 mm x 95 mm
 Taş Ölçüsü	(Stone Measure)	117 mm x 50 mm
 Ambalaj Ölçüsü	(Packing Measure)	310 mm x 317 mm



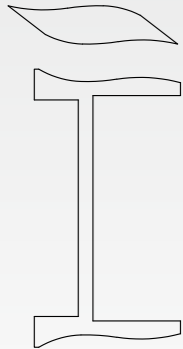
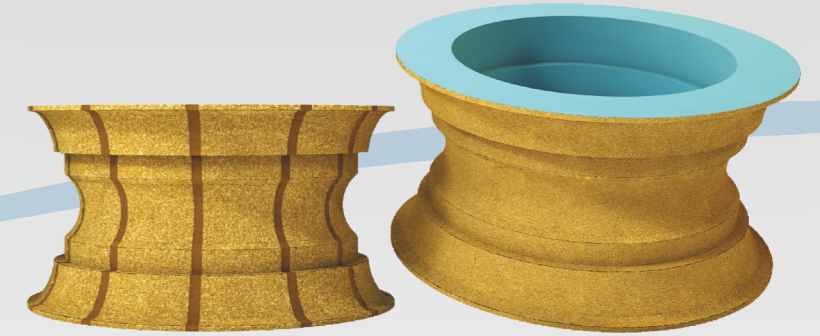
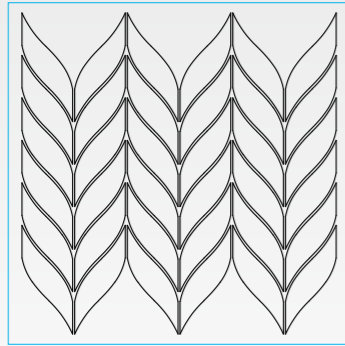
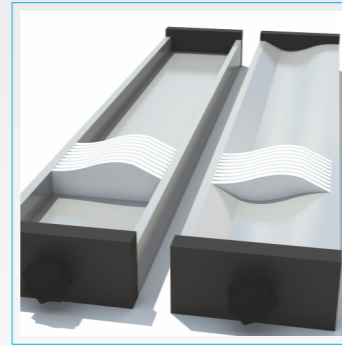
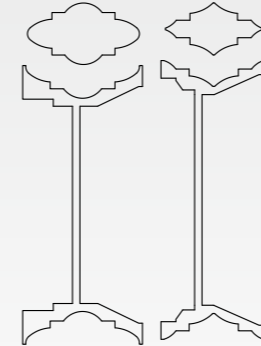
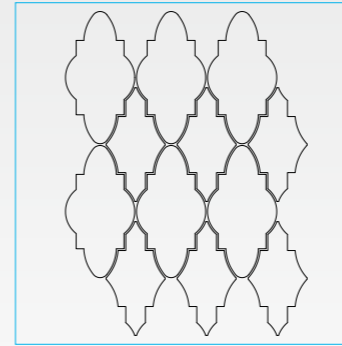
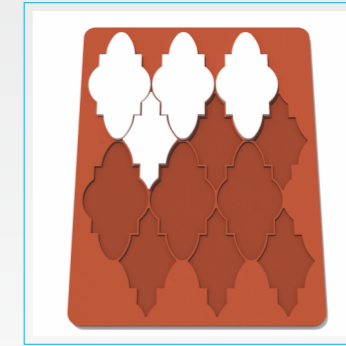
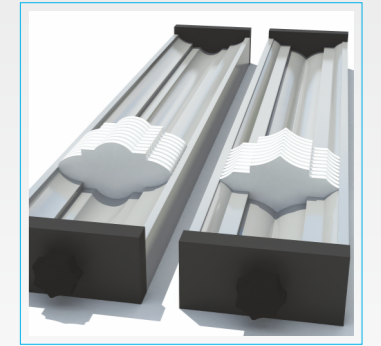
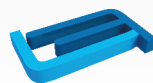

## Özel I

Teknik Özellikler		Size
 Profil Ölçüsü	(Profile Measure)	Ø250 mm x 160 mm Ø250 mm x 140 mm
 Taş Ölçüsü	(Stone Measure)	150 mm x 78 mm 130 mm x 67 mm
 Ambalaj Ölçüsü	(Packing Measure)	274 mm x 367 mm



Profil  
ÇizimiFile  
ÇizimiDizgi Kalıbı  
KauçukKesim Kalıbı  
AlüminyumProfil  
ÇizimiFile  
ÇizimiDizgi Kalıbı  
KauçukKesim Kalıbı  
Alüminyum

## Özel 2

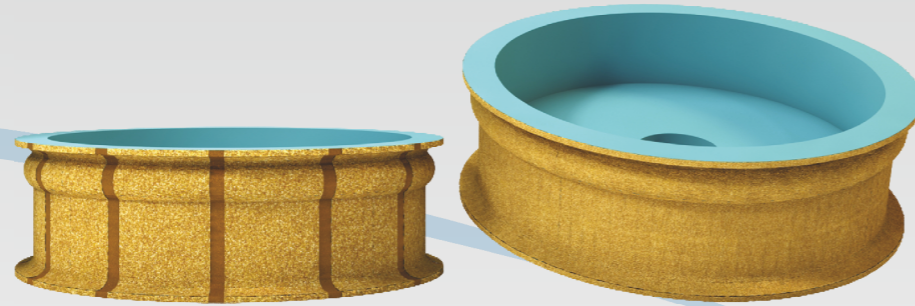
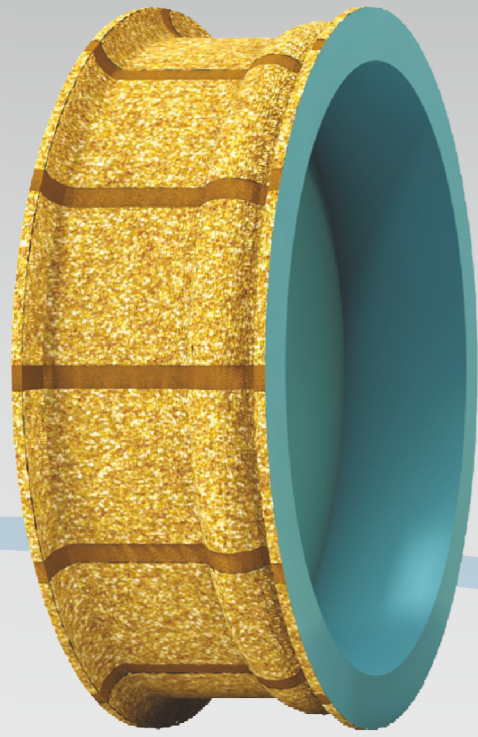
Teknik Özellikler		Size
 Profil Ölçüsü	(Profile Measure)	Ø250 mm x 92 mm
 Taş Ölçüsü	(Stone Measure)	83 mm x 20 mm
 Ambalaj Ölçüsü	(Packing Measure)	218 mm x 238 mm



## Yaprak

Teknik Özellikler		Size
 Profil Ölçüsü	(Profile Measure)	Ø250 mm x 98 mm
 Taş Ölçüsü	(Stone Measure)	94 mm x 34 mm
 Ambalaj Ölçüsü	(Packing Measure)	284 mm x 289 mm

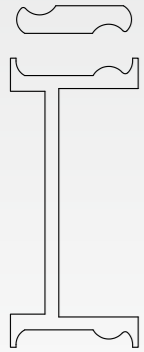
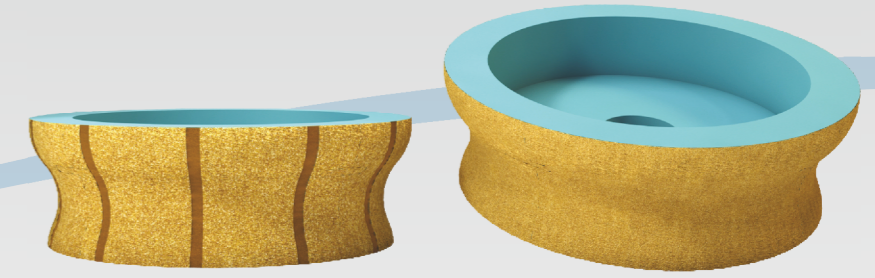
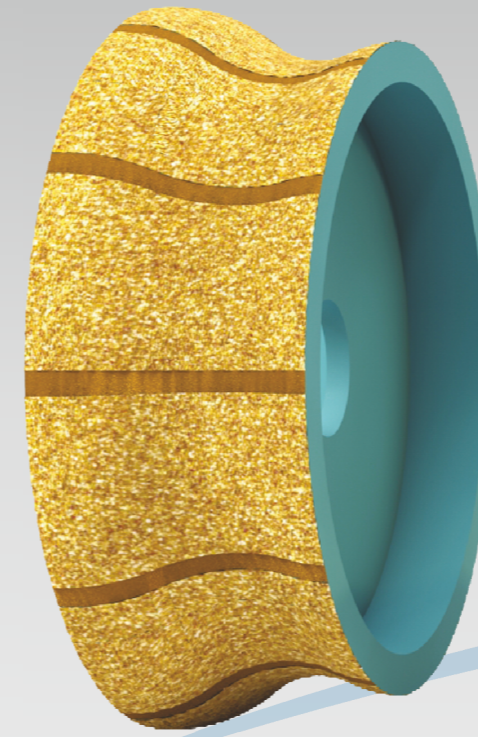

Profil Çizimi

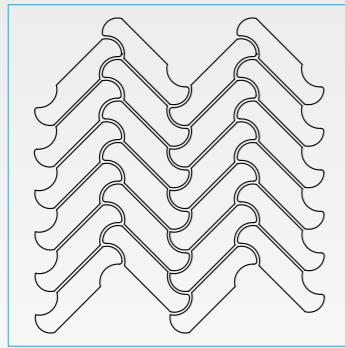

File Çizimi



Dizgi Kalıbı Kauçuk

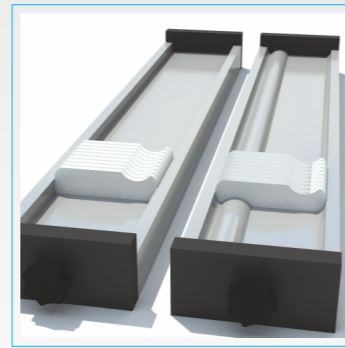

Kesim Kalıbı Alüminyum

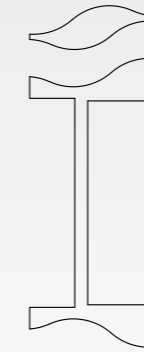

Profil Çizimi

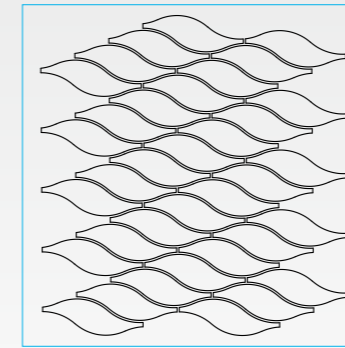

File Çizimi

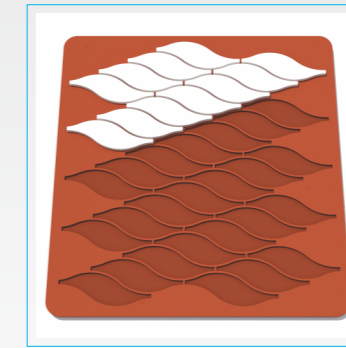

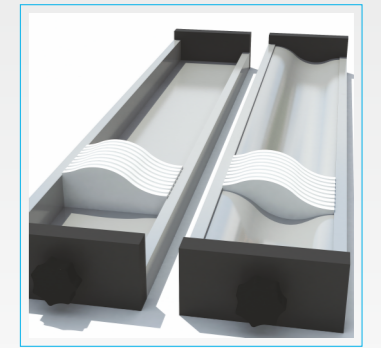

Dizgi Kalıbı Kauçuk

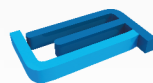

Kesim Kalıbı Alüminyum



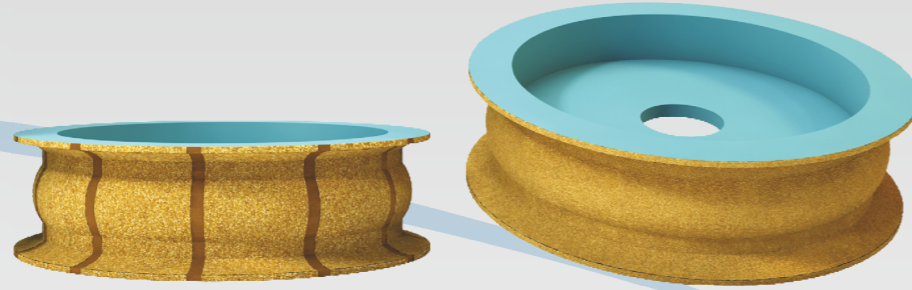
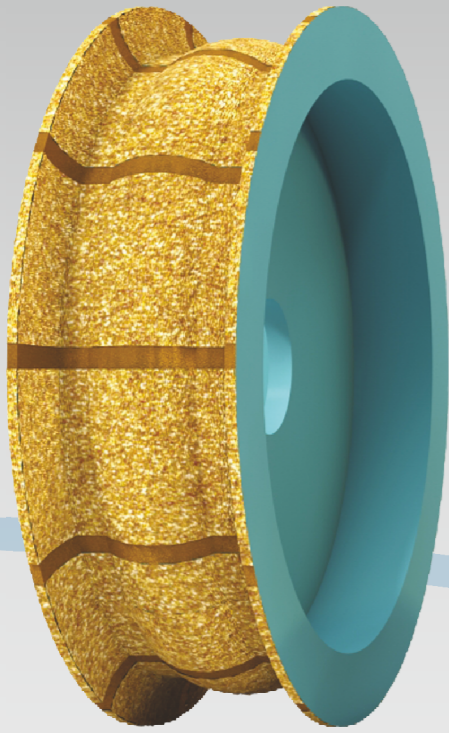

## Basket

Teknik Özellikler		Size	
 Profil Ölçüsü	(Profile Measure)	Ø250 mm	x 88 mm
 Taş Ölçüsü	(Stone Measure)	76 mm	x 40 mm
 Ambalaj Ölçüsü	(Packing Measure)	288 mm	x 288 mm



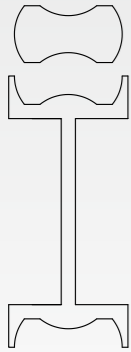
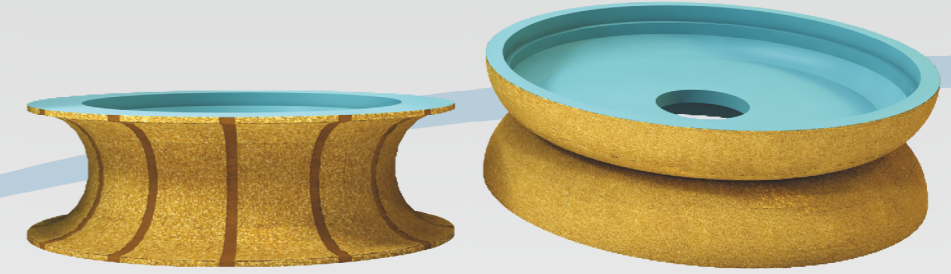
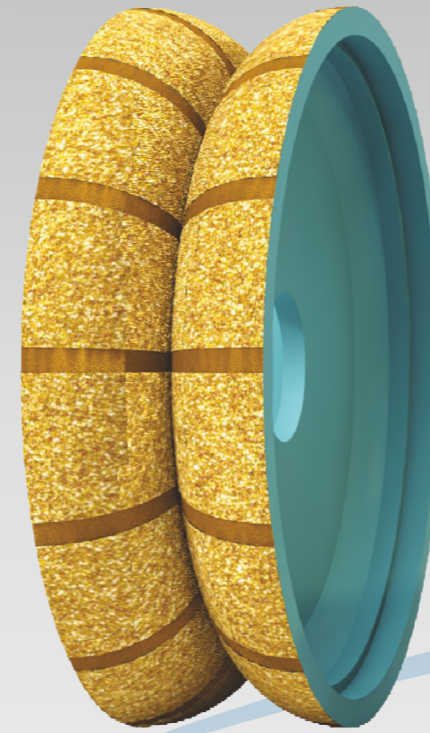
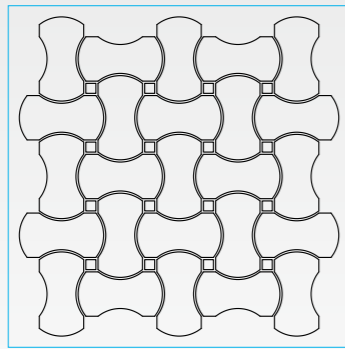
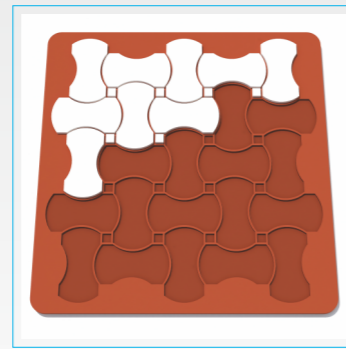
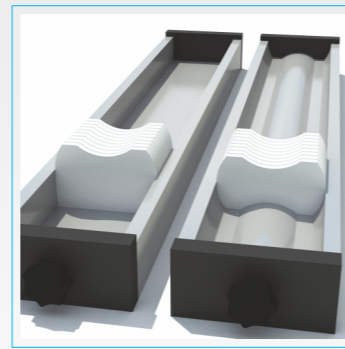
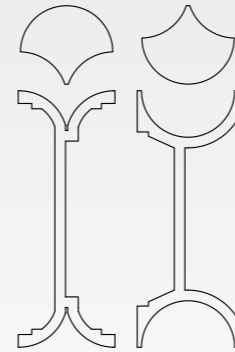
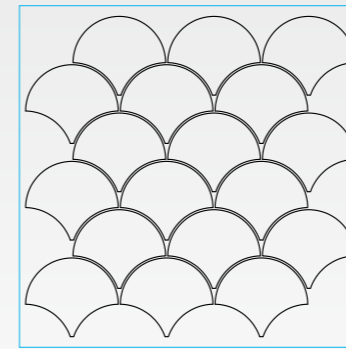
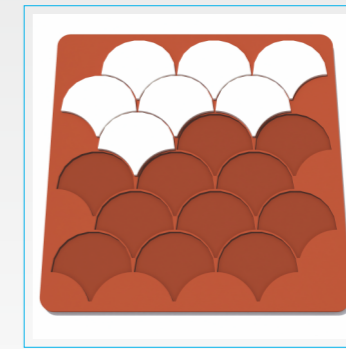
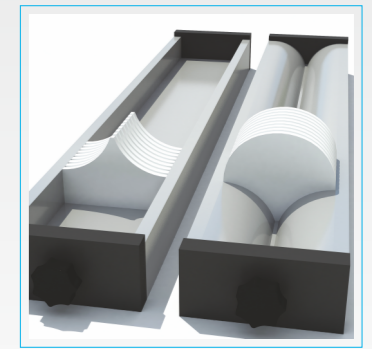
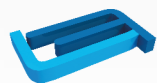

## Damla

Teknik Özellikler		Size	
 Profil Ölçüsü	(Profile Measure)	Ø250 mm	x 96 mm
 Taş Ölçüsü	(Stone Measure)	87 mm	x 74 mm
 Ambalaj Ölçüsü	(Packing Measure)	310 mm	x 300 mm



Profil  
ÇizimiFile  
ÇizimiDizgi Kalıbı  
KauçukKesim Kalıbı  
AlüminyumProfil  
ÇizimiFile  
ÇizimiDizgi Kalıbı  
KauçukKesim Kalıbı  
Alüminyum

## Arabesk

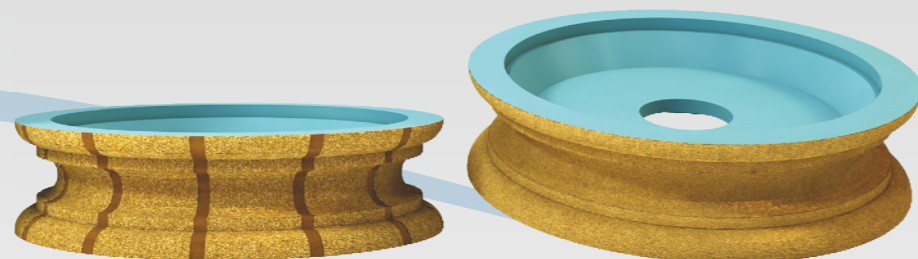
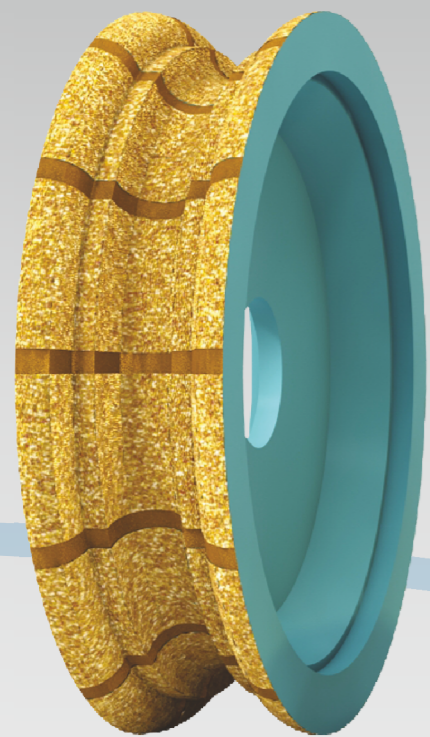
Teknik Özellikler		Size
 Profil Ölçüsü	(Profile Measure)	Ø250 mm x 87 mm
 Taş Ölçüsü	(Stone Measure)	75 mm x 65 mm
 Ambalaj Ölçüsü	(Packing Measure)	310 mm x 310 mm



## Limon

Teknik Özellikler		Size
 Profil Ölçüsü	(Profile Measure)	Ø250 mm x 87 mm
 Taş Ölçüsü	(Stone Measure)	75 mm x 38 mm
 Ambalaj Ölçüsü	(Packing Measure)	310 mm x 305 mm

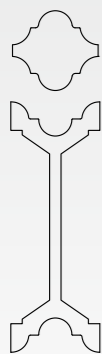
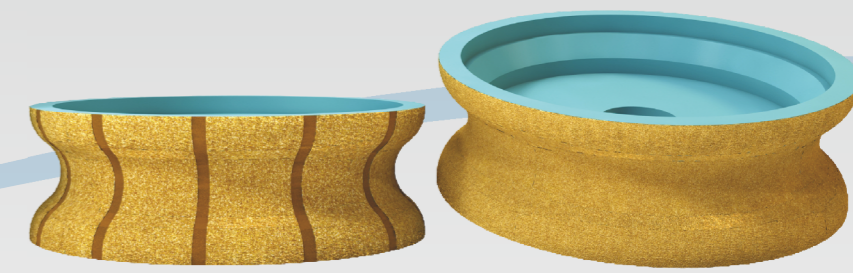
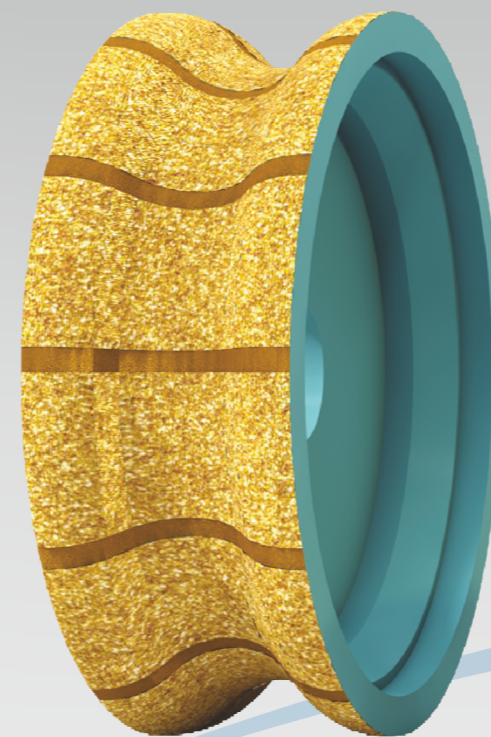

Profil Çizimi

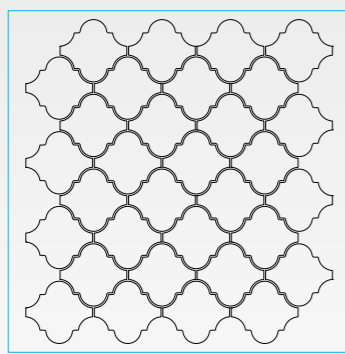

File Çizimi

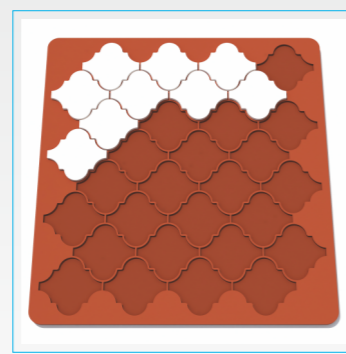

Dizgi Kalıbı Kauçuk

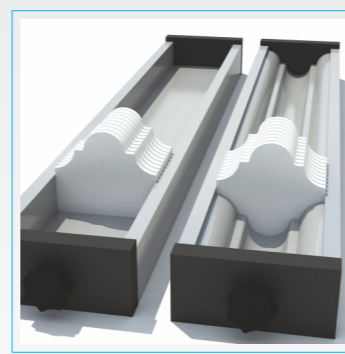

Kesim Kalıbı Alüminyum

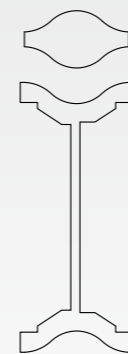

Profil Çizimi

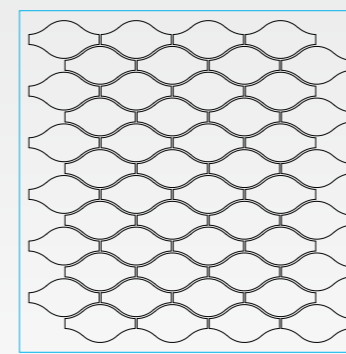

File Çizimi

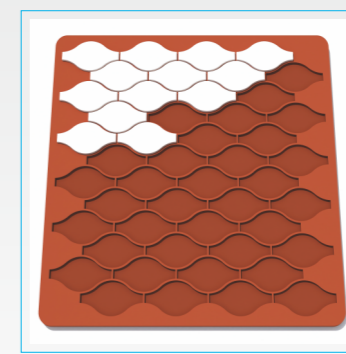

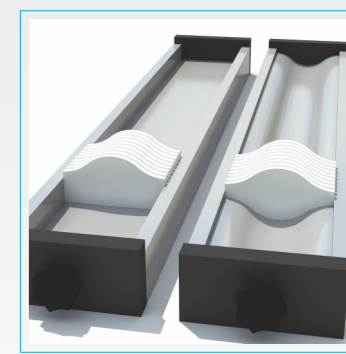

Dizgi Kalıbı Kauçuk

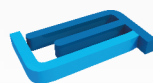

Kesim Kalıbı Alüminyum



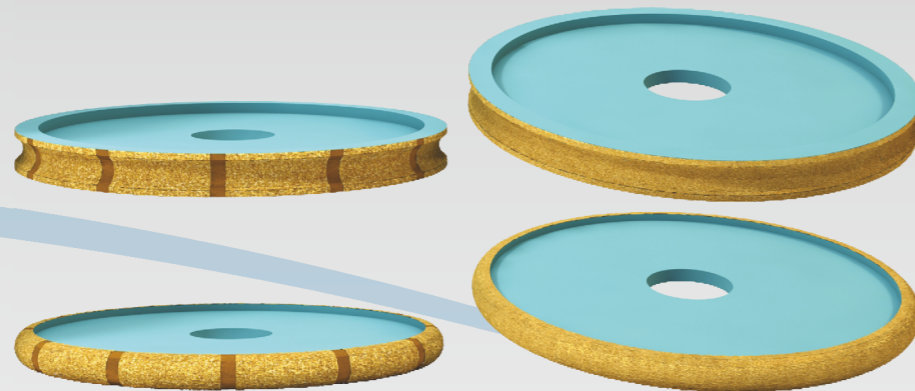

## Uçak

Teknik Özellikler		Size
 Profil Ölçüsü	(Profile Measure)	Ø250 mm x 26 mm
 Taş Ölçüsü	(Stone Measure)	71 mm x 56 mm
 Ambalaj Ölçüsü	(Packing Measure)	326 mm x 314 mm





## Kareli

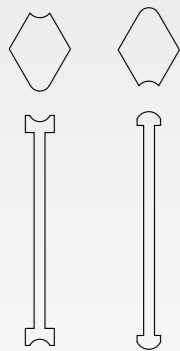
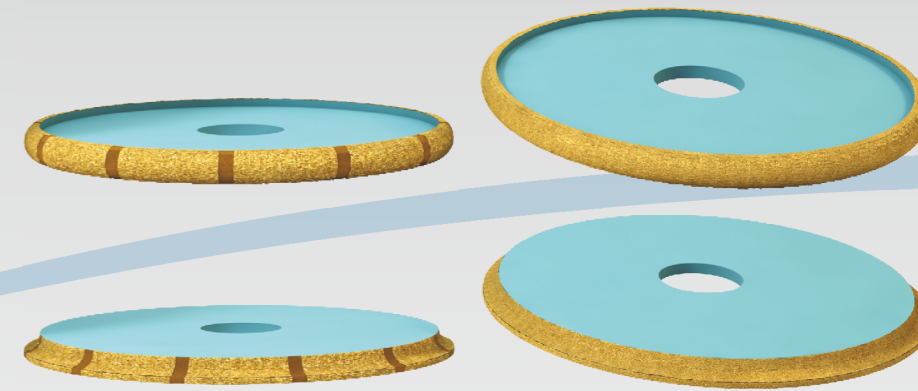
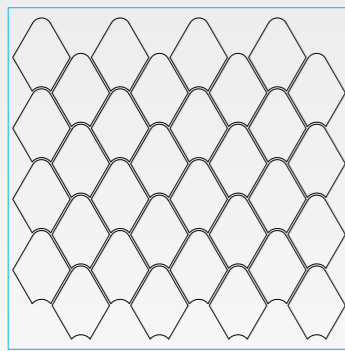
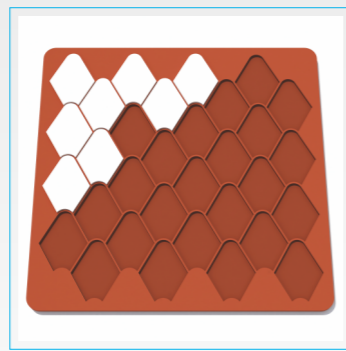
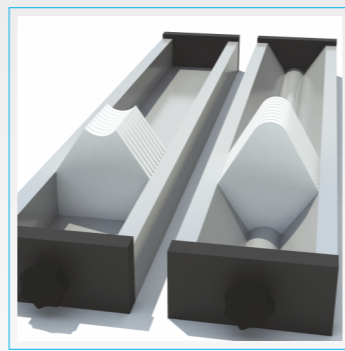
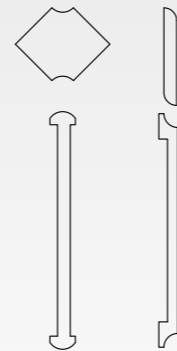
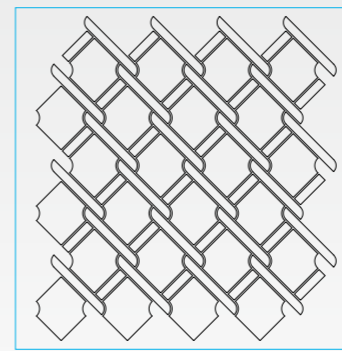
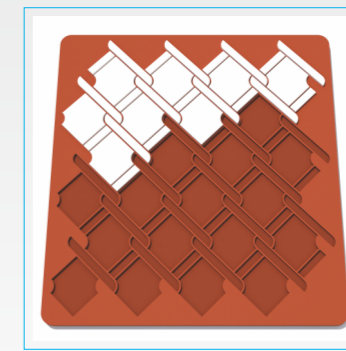
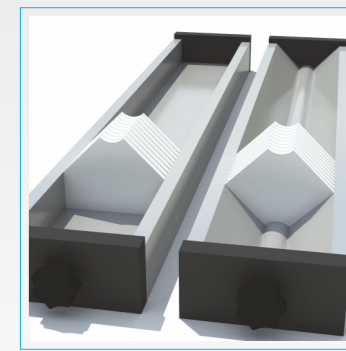
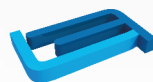

Teknik Özellikler		Size
 Profil Ölçüsü	(Profile Measure)	Ø250 mm x 20 mm
 Taş Ölçüsü	(Stone Measure)	52 mm x 52 mm
 Ambalaj Ölçüsü	(Packing Measure)	377 mm x 348 mm

Profil  
ÇizimiFile  
ÇizimiDizgi Kalıbı  
KauçukKesim Kalıbı  
AlüminyumProfil  
ÇizimiFile  
ÇizimiDizgi Kalıbı  
KauçukKesim Kalıbı  
Alüminyum

## Daire



Teknik Özellikler		Size
 Profil Ölçüsü	(Profile Measure)	Ø250 mm x 60 mm
 Taş Ölçüsü	(Stone Measure)	51, 41, 31, 19 mm
 Ambalaj Ölçüsü	(Packing Measure)	305 mm x 305 mm

## Hexagon

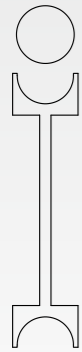
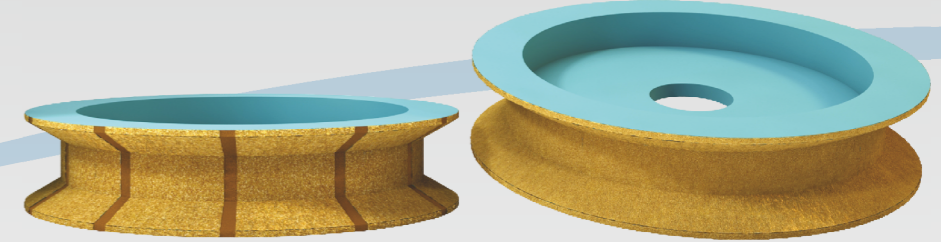
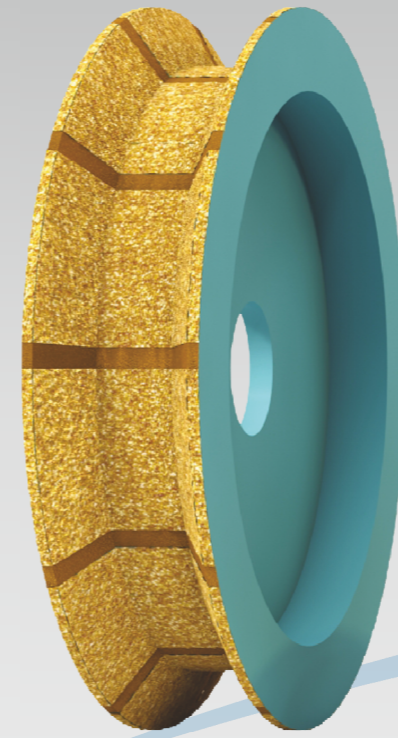
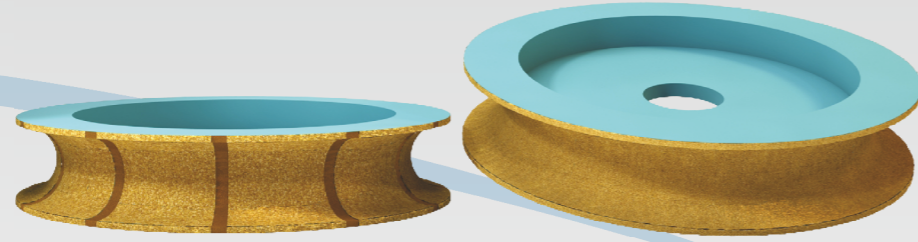
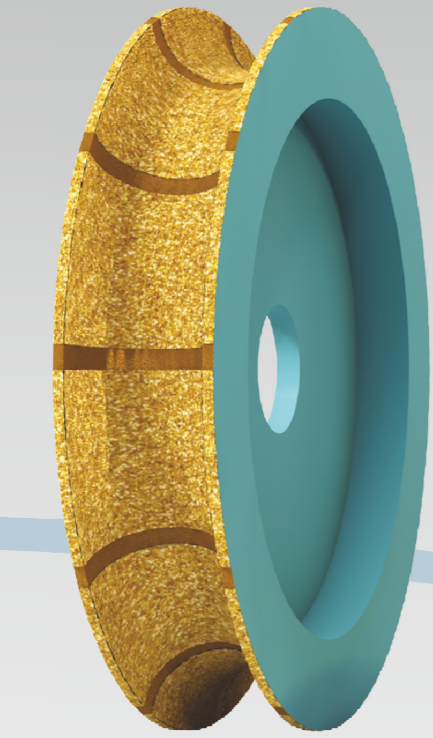
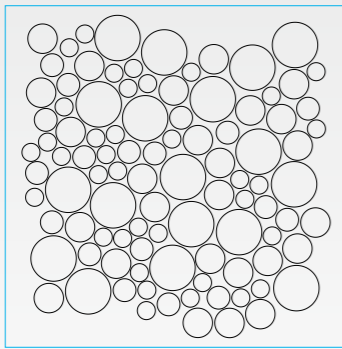
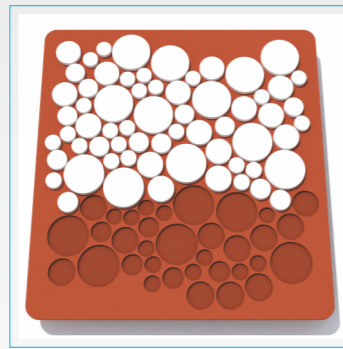
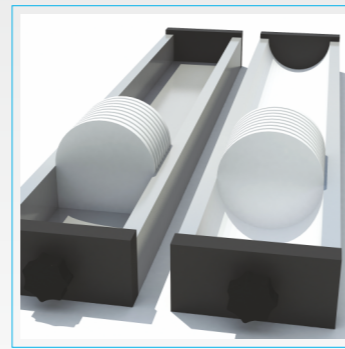
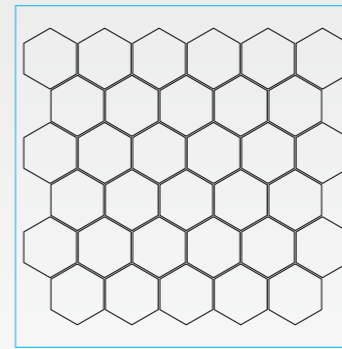
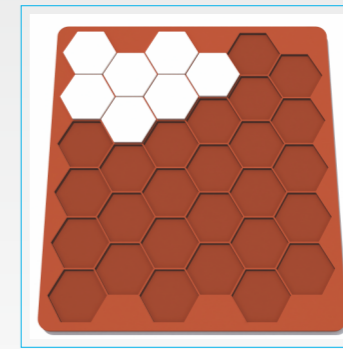
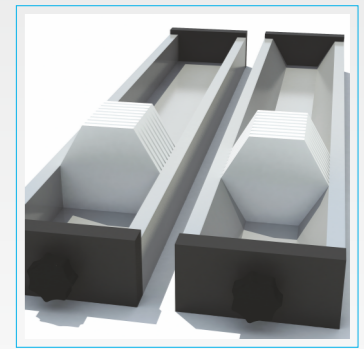
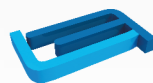
Teknik Özellikler		Size
 Profil Ölçüsü	(Profile Measure)	Ø250 mm x 65 mm
 Taş Ölçüsü	(Stone Measure)	56 mm x 48.5 mm
 Ambalaj Ölçüsü	(Packing Measure)	310 mm x 310 mm



Profil  
ÇizimiFile  
ÇizimiDizgi Kalıbı  
KauçukKesim Kalıbı  
AlüminyumProfil  
ÇizimiFile  
ÇizimiDizgi Kalıbı  
KauçukKesim Kalıbı  
Alüminyum

## DK-1055

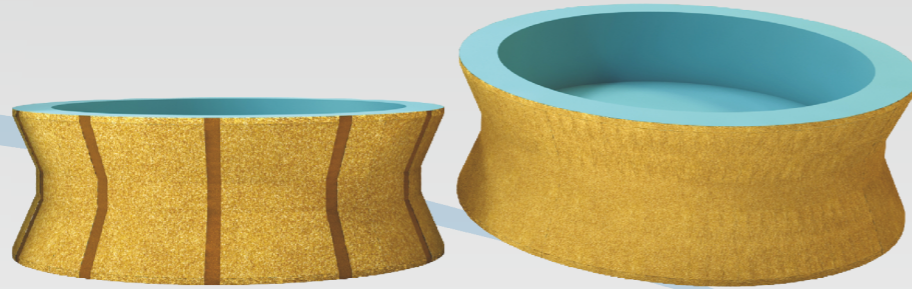
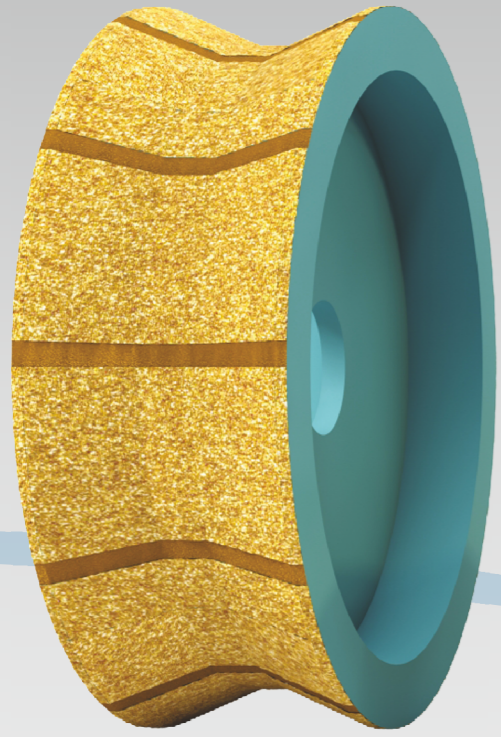
Teknik Özellikler		Size
 Profil Ölçüsü	(Profile Measure)	Ø250 mm x 100 mm
 Taş Ölçüsü	(Stone Measure)	92 mm x 47 mm
 Ambalaj Ölçüsü	(Packing Measure)	306 mm x 304 mm



## Picket

Teknik Özellikler		Size
 Profil Ölçüsü	(Profile Measure)	Ø250 mm x 110 mm
 Taş Ölçüsü	(Stone Measure)	101 mm x 36 mm
 Ambalaj Ölçüsü	(Packing Measure)	355 mm x 337 mm

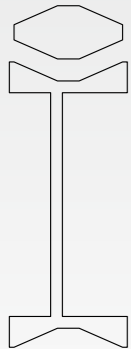
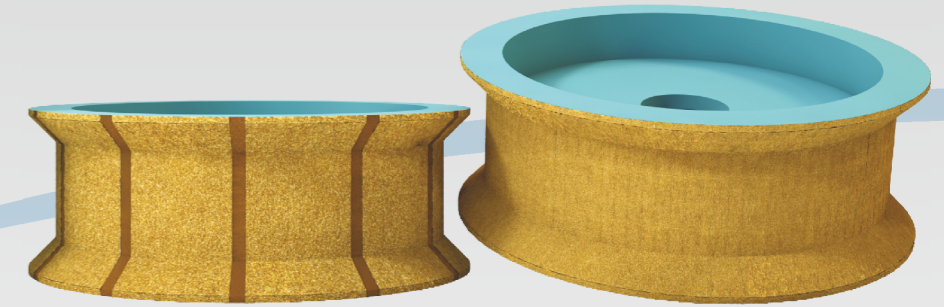
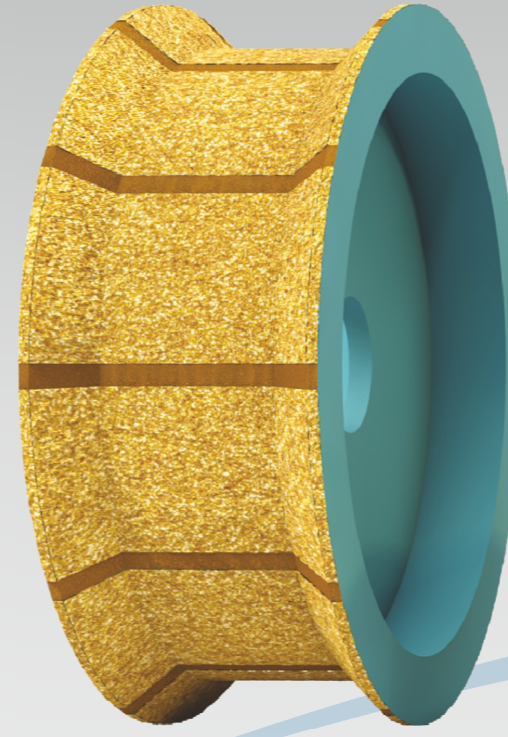

Profil Çizimi

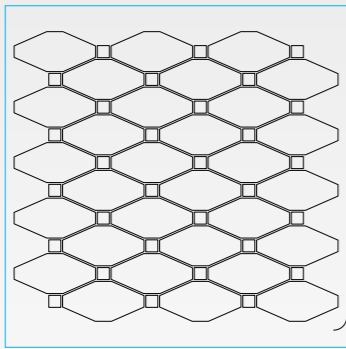

File Çizimi

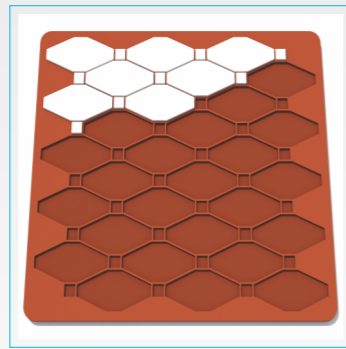
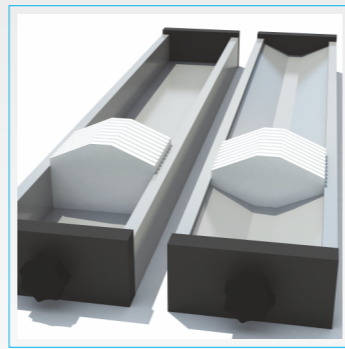
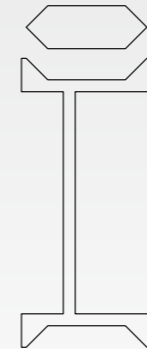
Dizgi Kalıbı  
KauçukKesim Kalıbı  
Alüminyum

Profil Çizimi

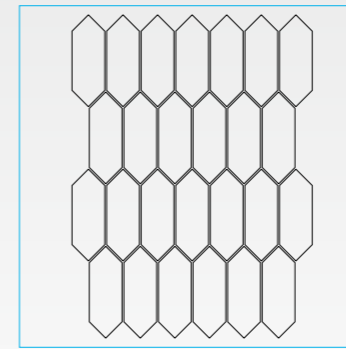

File Çizimi

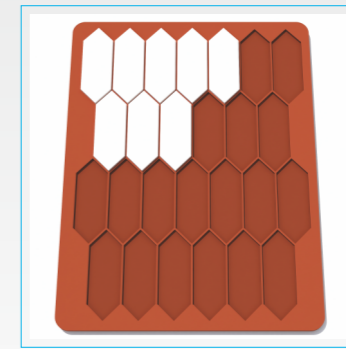
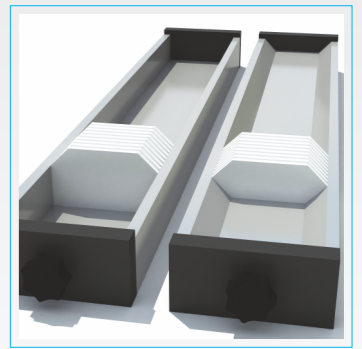
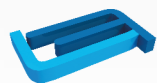
Dizgi Kalıbı  
KauçukKesim Kalıbı  
Alüminyum



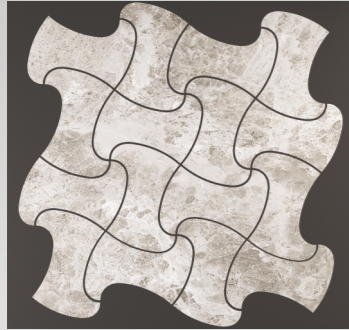

Kanca



Delray

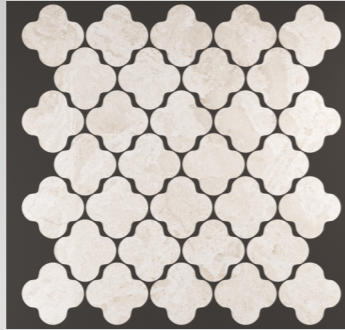

Papatya

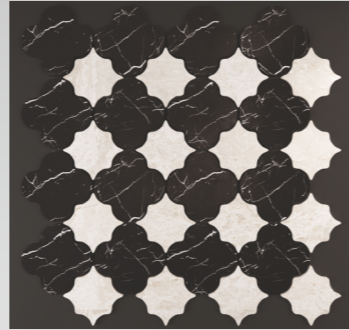

Papatya 2

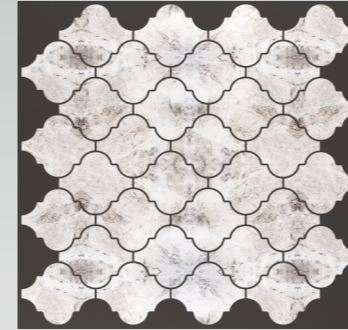

Arabesk

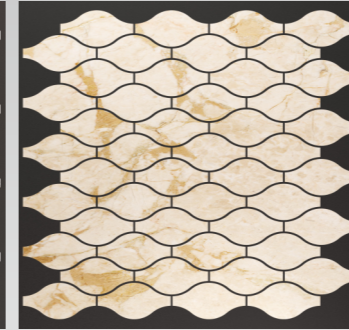

Limon

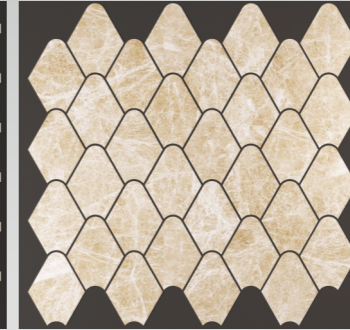

Uçak

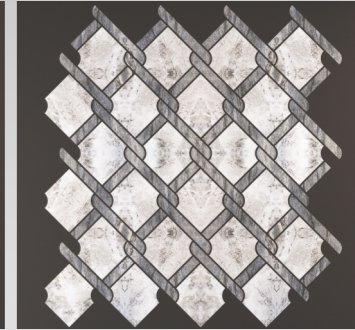

Kareli



Kemik



İnce Limon



İnce yaprak



Özel 1

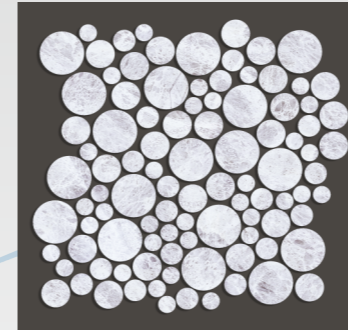

Daire

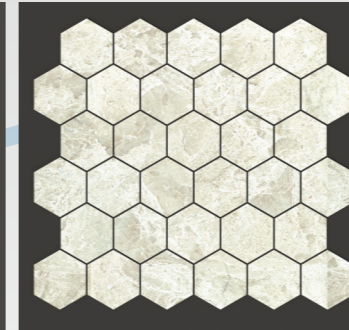

Hexagon

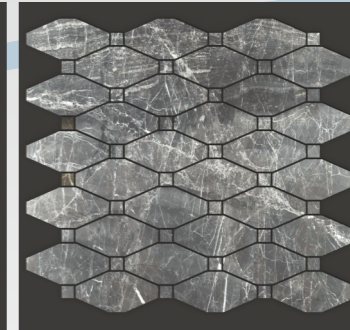

DK-1055

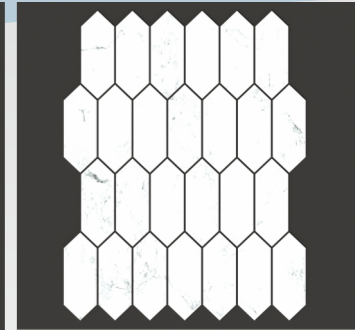

Picket



Özel 2

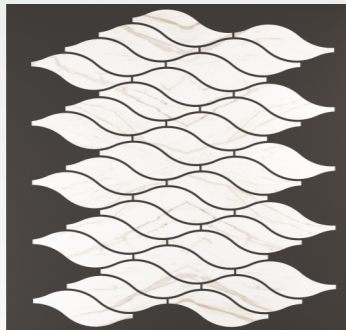

Yaprak

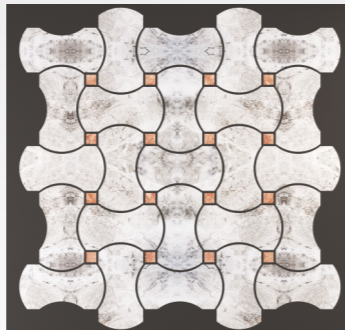

Basket



Damla

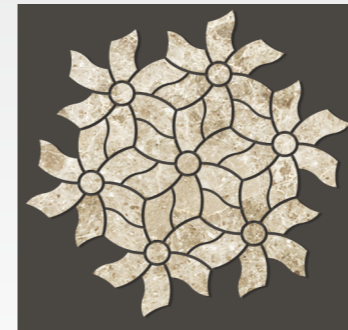

Özel 3

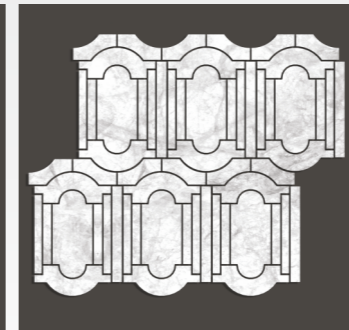

Özel 4



Özel 5



Özel 6

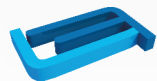

## Poolcoping Profiller

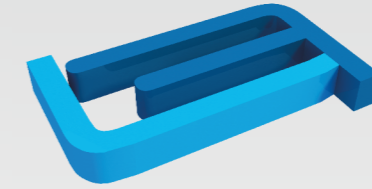
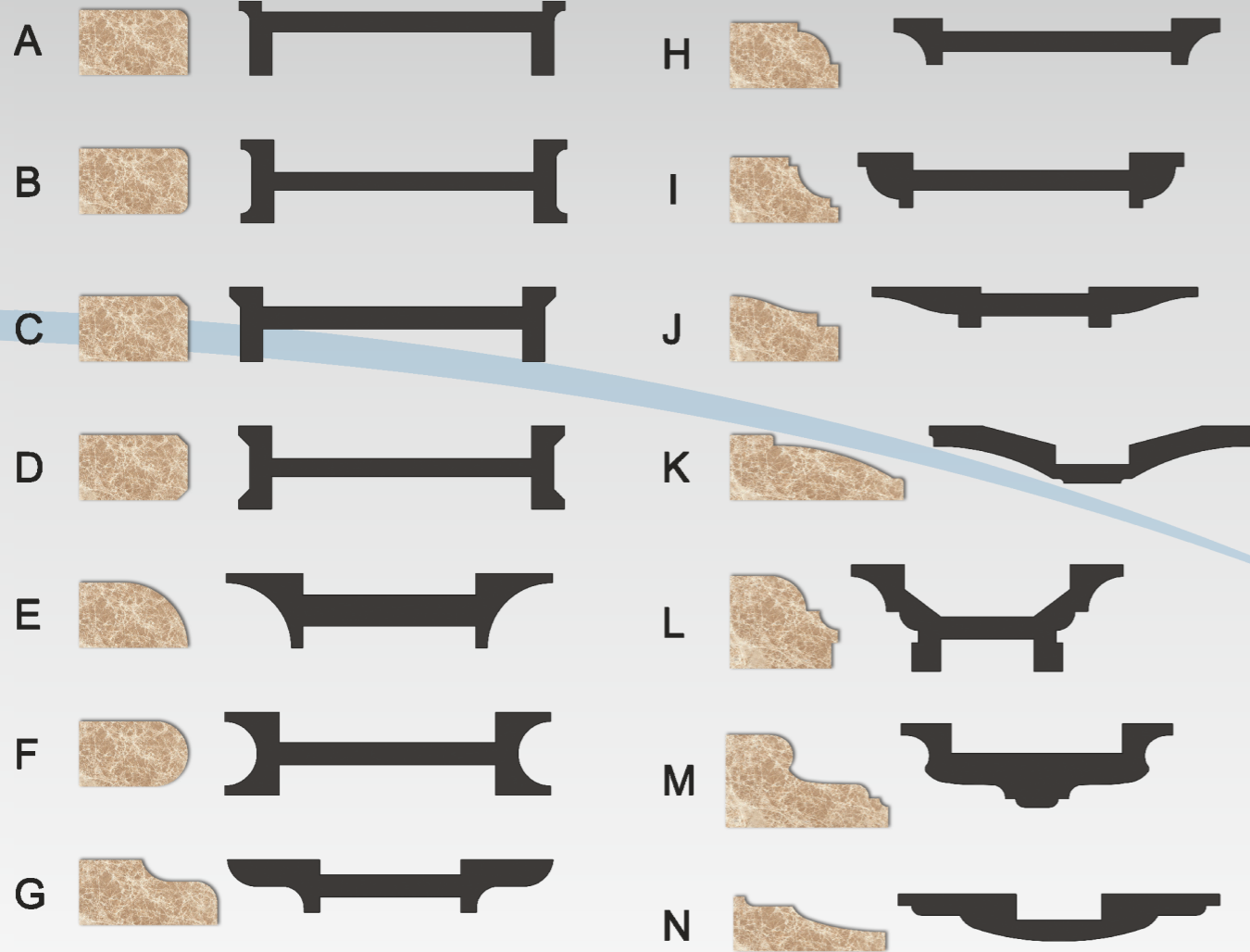

**BİRLİK TİCARET**

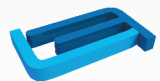



BİRLİK TİCARET MERMER KESİCİLERİ VE AŞINDIRICILARI İMALATI

O.S.B. 5.Cadde Elko Sanayi Sitesi No:10E/2 AFYONKARAHİSAR - TÜRKİYE  
0 (532) 695 39 61 - 0 (532) 481 10 16  
e-mail : birlik@birliktic.com

[www.birliktic.com](http://www.birliktic.com)